

illumiwall2.0

RGB+W & Static White



tivoli



Project: _____ TYPE: _____

- Tivoli's illumiwall 2.0 now available in RGB+W
- DMX controlled 1 pixel per sheet or 9 pixels per sheet option
- Suitable for back-lit, stage, entertainment and architectural applications
- Flexilbe and cuttable down to 4"x4" size to meet any sqare foot space needed



Sheet Dimensions

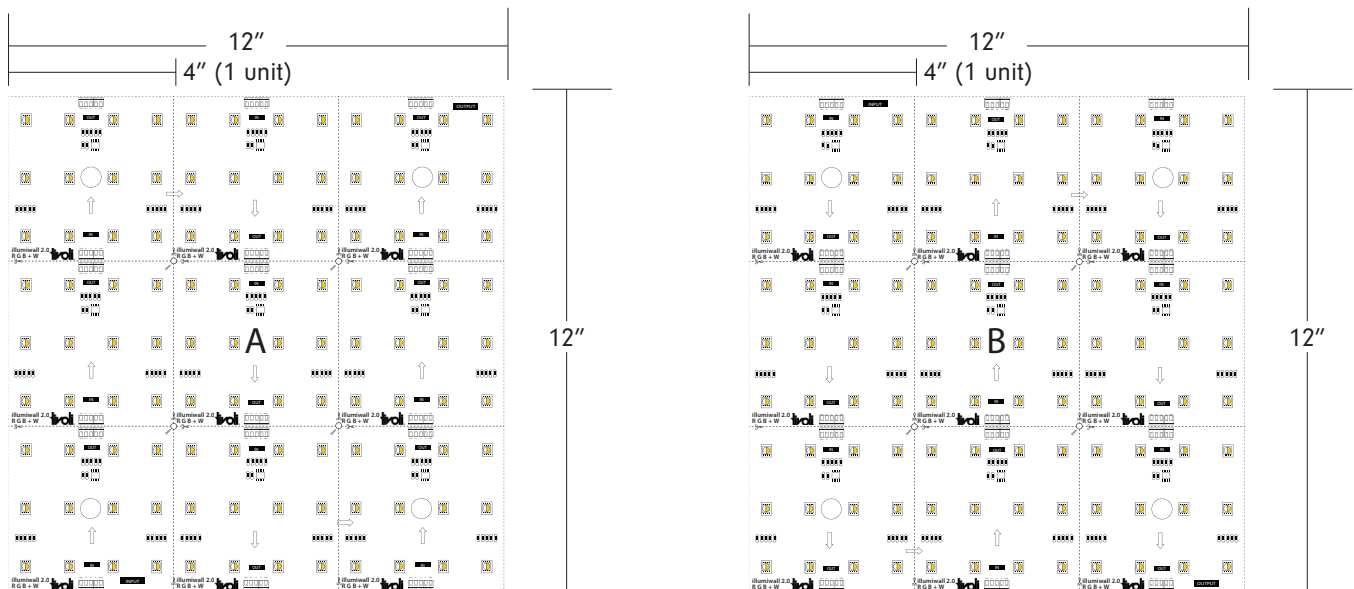

Order Specification Guide

Note: A layout/drawing must accompany each order showing run length and location

PRODUCT CODE	LED TYPE	SHEET TYPE	PIXEL ADDRESSING	VOLTAGE
ILW2	RGBW			24
ILW2 = Illumiwall 2	RGBW = Red, Green, Blue, White (4000K)	A = Sheet A B = Sheet B	01 = 12"x12" (9 pixels) 02 = 12"x12" (1 pixel)	24 = 24V DC

Specifications

Output @ 95%

Lumens All On (lm/ft ²)	918.55
Efficacy All On	51.04
Lumens White (lm/ft ²)	331.88 (4000K)
Efficacy White	50.27
Lumens Red (lm/ft ²)	140.82
Efficacy Red	21.21
Lumens Green (lm/ft ²)	376.21
Efficacy Green	56.01
Lumens Blue (lm/ft ²)	77.5
Efficacy Blue	11.69
LED Channels	Red / Green / Blue / White (4000K)
Wavelength	Red 631 (380nm-780nm), Green 519 (380nm-780nm), Blue 464 (380nm-780nm)

Electrical

Input Voltage	24V DC
Power Consumption (W/ft ²)	Sheet: 18W / Unit: 2W
Maximum Run	5 sheet per circuit

Control

Control System	DMX 512
Dimming	DMX

Physical

Dimensions	Sheet: 12"x12"x0.1" / Unit: 4"x4"
LED	5050 RGBW 4 in 1
LED Qty	Sheet: 108 pcs. / Unit: 9 pcs.
Beam Angle	120°
Cut Increment	4"
Copper Trace	2 Ounce
Adhesive	3M VHB
Operating Temperature	-20°C to 45°C (-4°F to 113°F)

Certification and Testing

Certification	cULus, RoHS, CE
Environment	Dry/Damp Location
IP Rating	IP54 (Conformally Coated)
Life Span @ 25%	90,000 hrs.
Warranty	3 years

Photometrics - All On

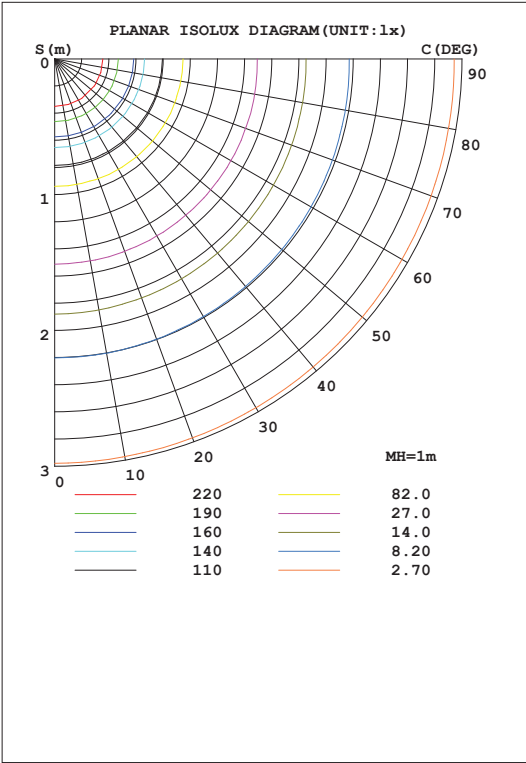
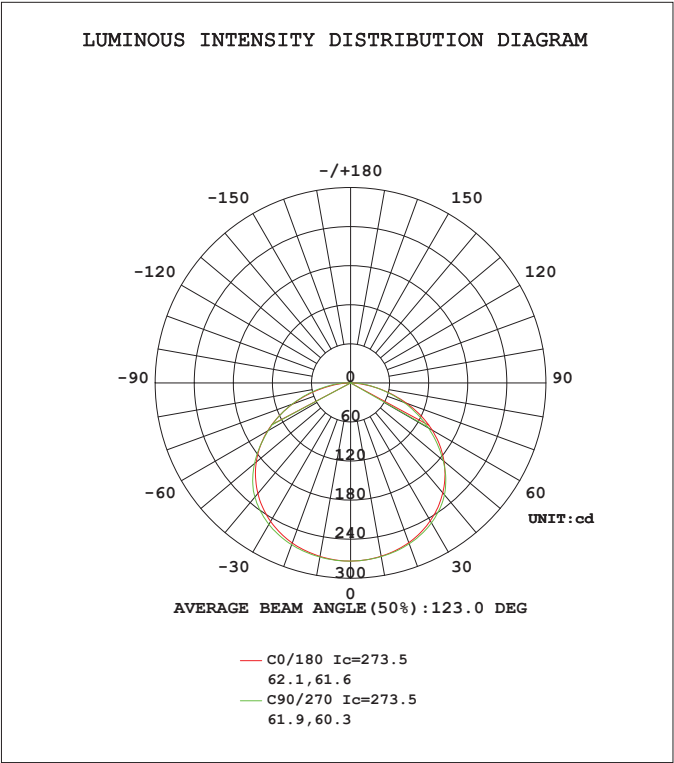

Flux out: 703.8 lm

Height	Eavg, Emax	Angle: 122.22deg	Diameter
1m	63.33, 273.61x		362.42cm
2m	15.83, 68.391x		724.84cm
3m	7.037, 30.401x		1087.26cm
4m	3.958, 17.101x		1449.68cm
5m	2.533, 10.941x		1812.10cm
6m	1.759, 7.5991x		2174.51cm
7m	1.293, 5.5831x		2536.93cm
8m	0.9896, 4.2741x		2899.35cm
9m	0.7819, 3.3771x		3261.77cm
10m	0.6333, 2.7361x		3624.19cm

Photometrics - White

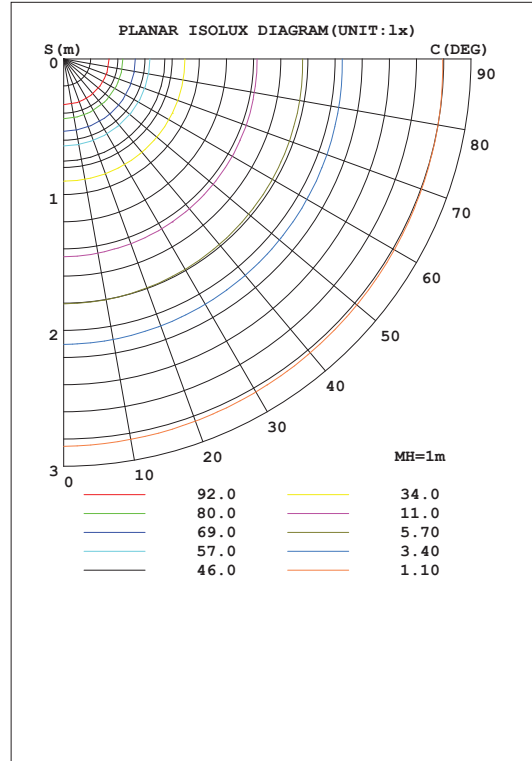
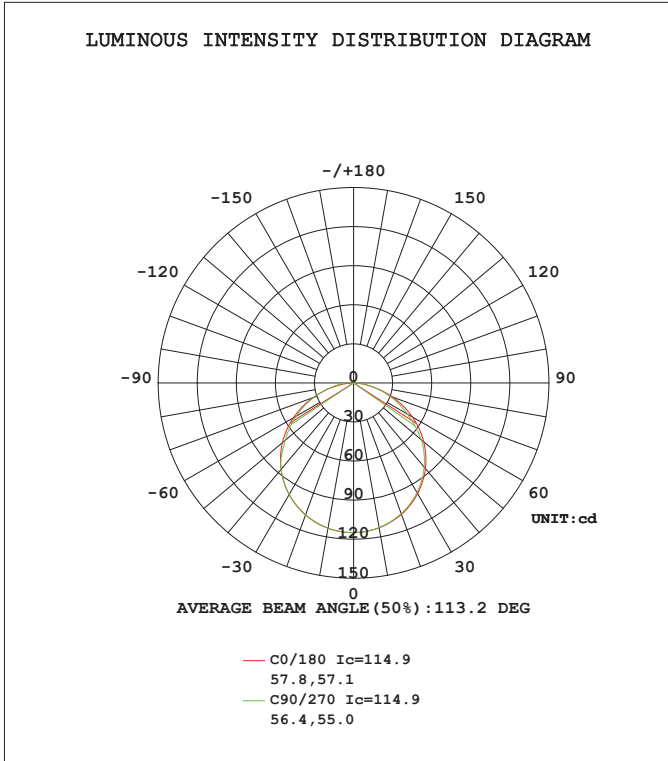

Flux out: 241.5 lm

Height	Eavg, Emax	Angle: 111.42deg	Diameter
1m	34.98, 115.01x		293.32cm
2m	8.744, 28.741x		586.64cm
3m	3.886, 12.771x		879.96cm
4m	2.186, 7.1861x		1173.28cm
5m	1.399, 4.5991x		1466.60cm
6m	0.9715, 3.1941x		1759.92cm
7m	0.7138, 2.3461x		2053.24cm
8m	0.5465, 1.7961x		2346.56cm
9m	0.4318, 1.4191x		2639.88cm
10m	0.3498, 1.1501x		2933.19cm

Photometrics - Red

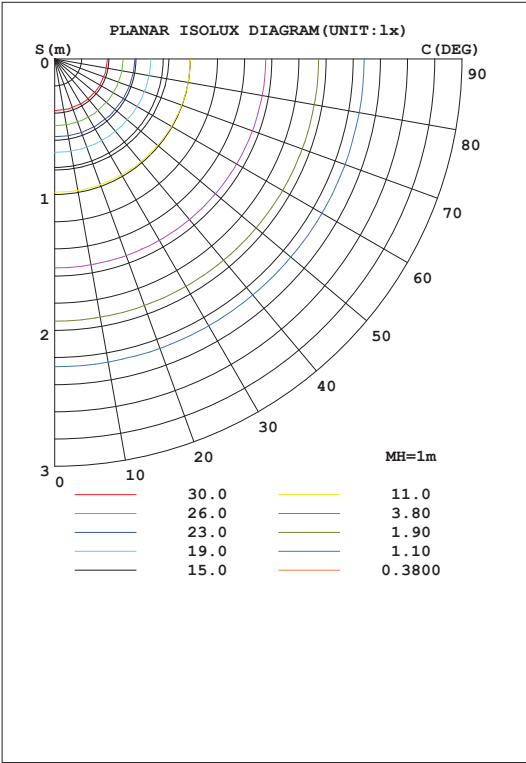
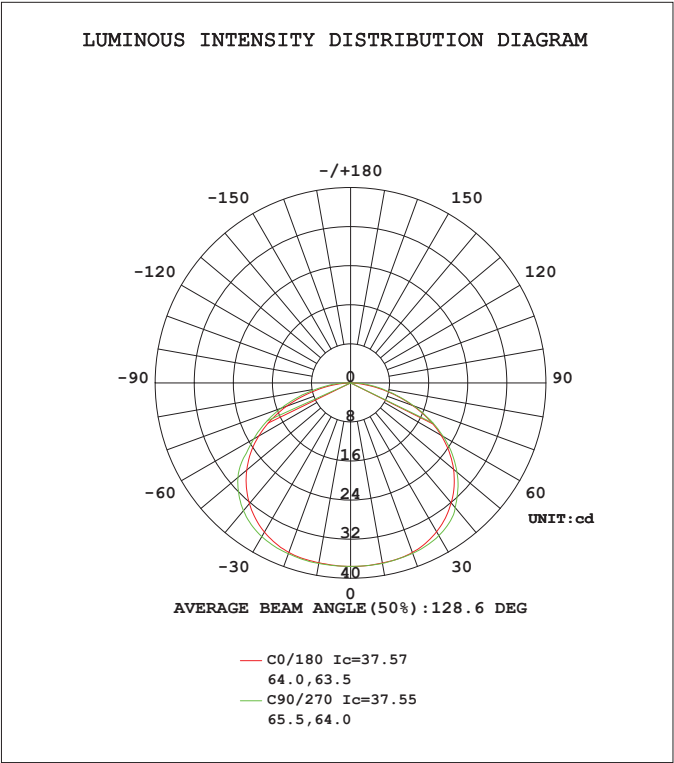

Flux out: 107.1 lm

Height	Eavg, Emax	Angle: 127.53deg	Diameter
1m	8.110, 37.581x		405.82cm
2m	2.028, 9.3941x		811.64cm
3m	0.9012, 4.1751x		1217.46cm
4m	0.5069, 2.3491x		1623.27cm
5m	0.3244, 1.5031x		2029.09cm
6m	0.2253, 1.0441x		2434.91cm
7m	0.1655, 0.76691x		2840.73cm
8m	0.1267, 0.58711x		3246.55cm
9m	0.1001, 0.46391x		3652.37cm
10m	0.0811, 0.37581x		4058.19cm

Photometrics - Green

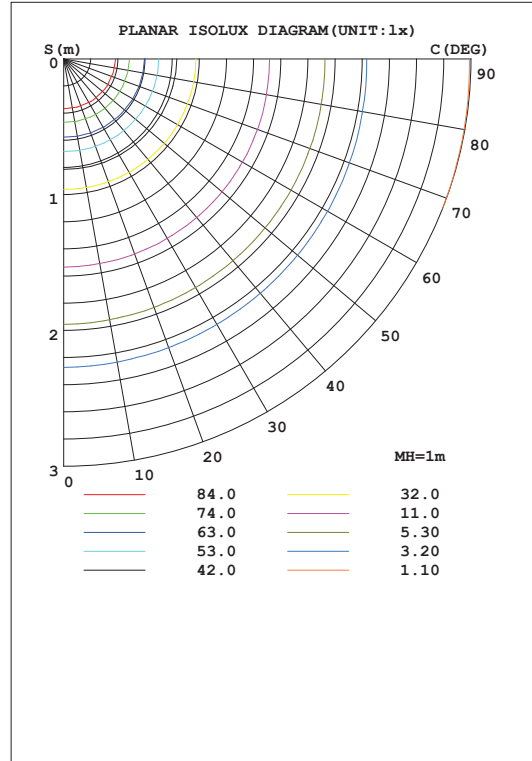
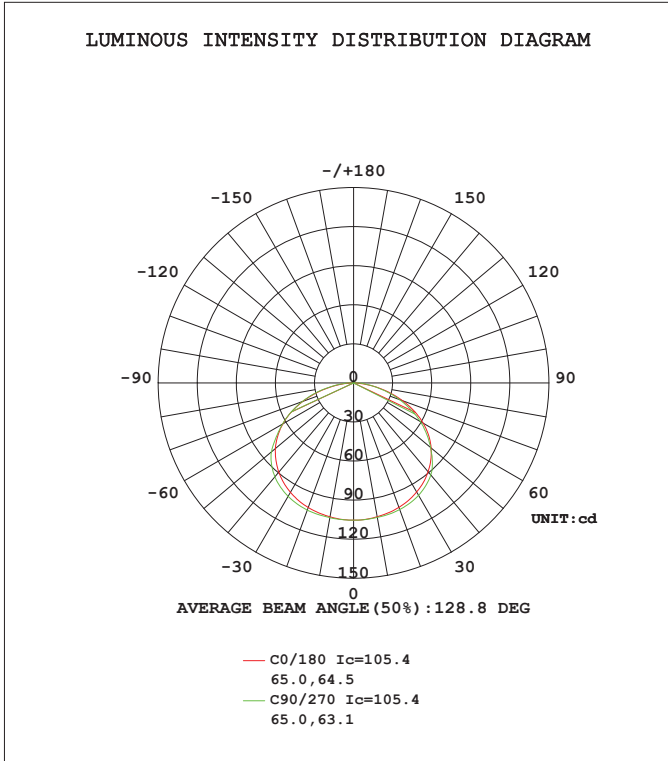

Flux out:302.4 lm

Height	Eavg,Emax	Angle:128.11deg	Diameter
1m	20.93,105.41x		411.04cm
2m	5.233,26.351x		822.07cm
3m	2.326,11.711x		1233.11cm
4m	1.308,6.5871x		1644.15cm
5m	0.8373,4.2161x		2055.19cm
6m	0.5815,2.9271x		2466.22cm
7m	0.4272,2.1511x		2877.26cm
8m	0.3271,1.6471x		3288.30cm
9m	0.2584,1.3011x		3699.33cm
10m	0.2093,1.0541x		4110.37cm

Photometrics - Blue

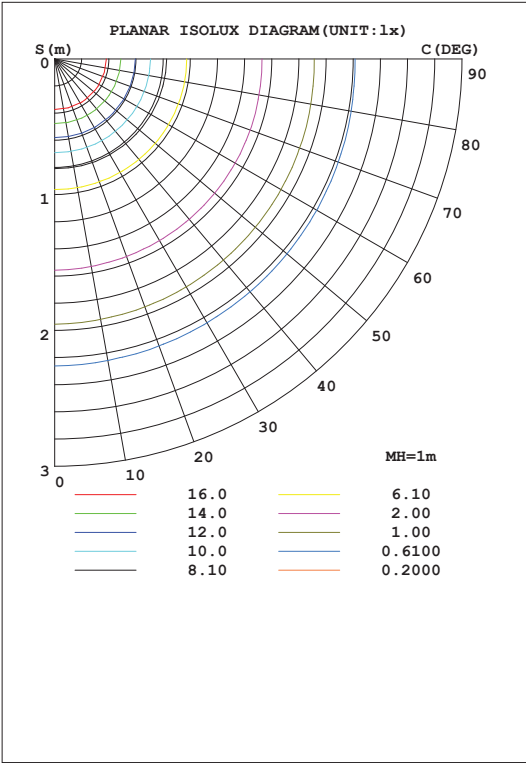
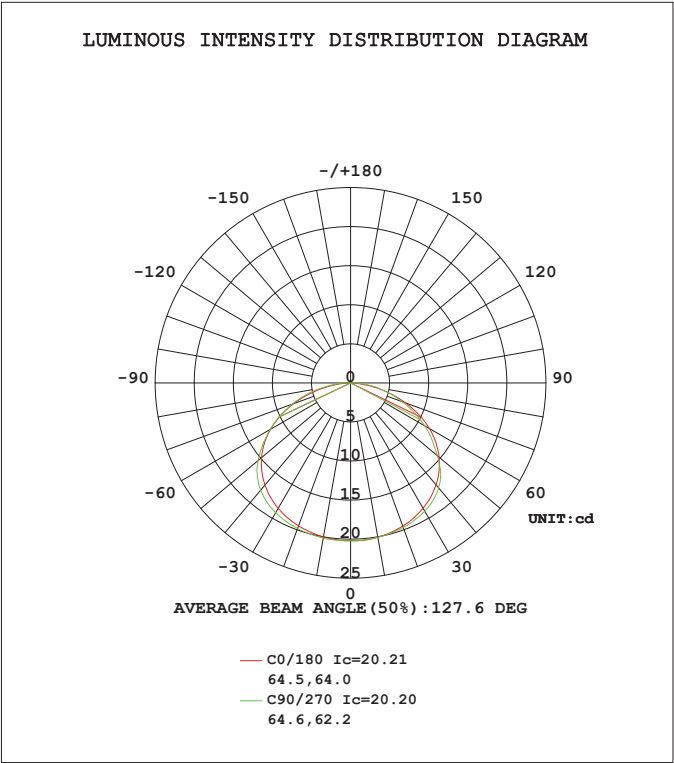

Flux out: 56.45 lm

Height	Eavg, Emax	Angle: 126.79deg	Diameter
1m	4.275, 20.201x		399.28cm
2m	1.069, 5.0501x		798.56cm
3m	0.4750, 2.2451x		1197.83cm
4m	0.2672, 1.2631x		1597.11cm
5m	0.1710, 0.80811x		1996.39cm
6m	0.1187, 0.56121x		2395.67cm
7m	0.0872, 0.41231x		2794.94cm
8m	0.0668, 0.31571x		3194.22cm
9m	0.0528, 0.24941x		3593.50cm
10m	0.0427, 0.20201x		3992.78cm

Sheet Spacing Layout & Flow

- 20 AWG multi-color wire provided by Tivoli for connection between illumiwall 2.0 A/B sheet(s)
- Panels come in A and B configuration for data and power flow direction
- Push-in connection for quick and secure power and data installation
- Suggested install panel with 0.5" gap between all panels, allowing for wire passage to eliminate drill holes and in-wall wiring
- Panels come with 3M backing and (4) screw holes for surface mount application (screws not included)

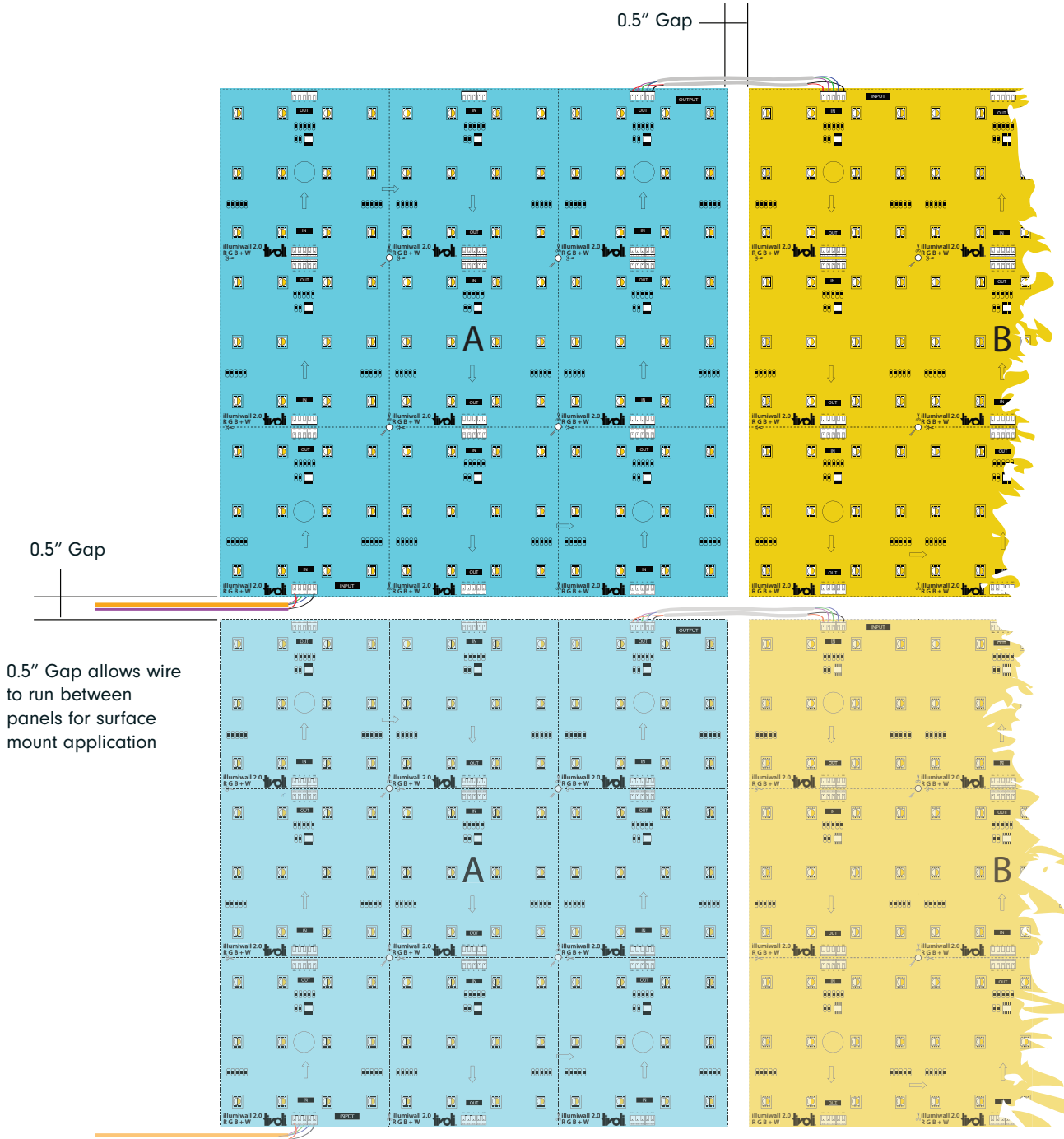

Data & Power Flow

20 AWG multi-color wire provided by Tivoli for connection between illumiwall 2.0 A/B sheet(s)

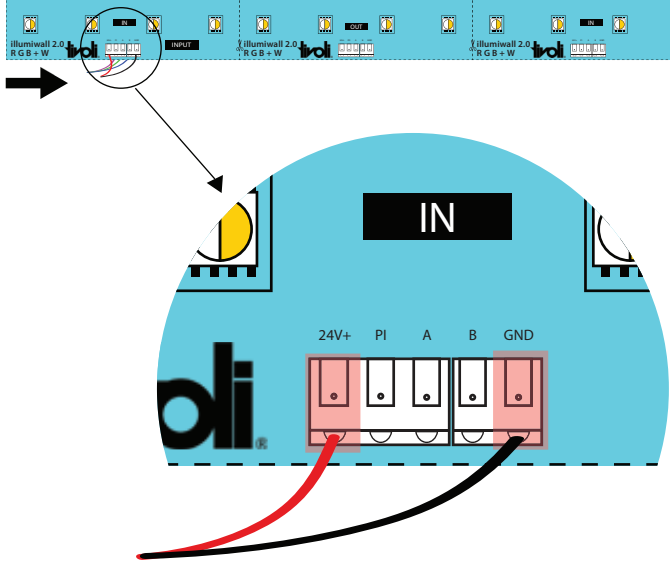
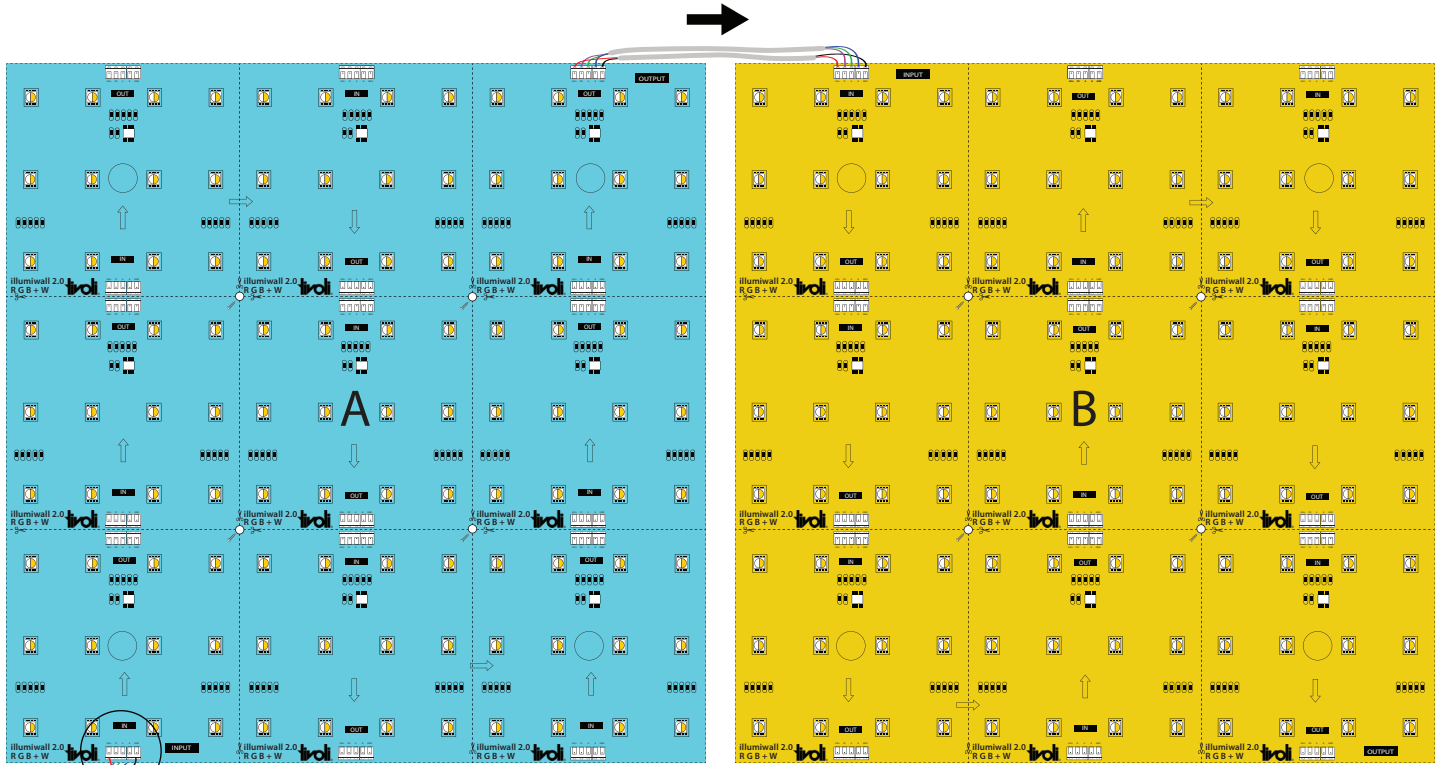

Power connection

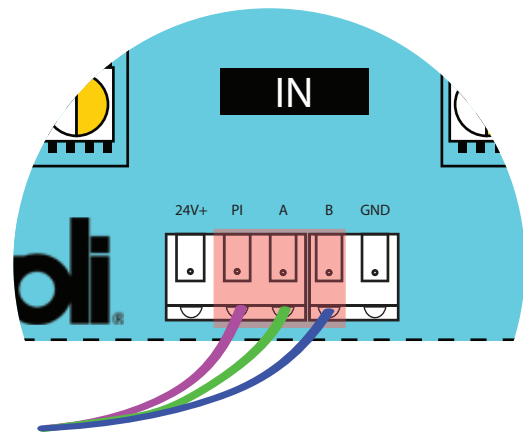

Data connection

Key & Software Levels

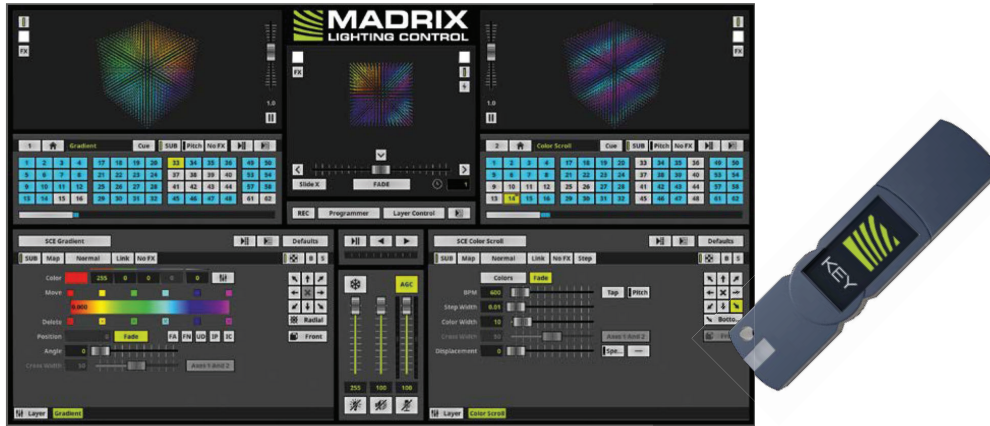

MADRIX KEY

A USB dongle unlocks the software’s full output. You can freely switch between different PCs as it is not bound to a specific one. It only needs to be activated online once.

MADRIX 5 LICENSE UPGRADES

You can easily upgrade your MADRIX 5 KEY to any higher license at any time, increasing the available output.

MADRIX 5 Key & Software Cat No	MDRX-LC-5S	MDRX-LC-5E	MDRX-LC-5B	MDRX-LC-5P	MDRX-LC-5U	MDRX-LC-5M
Level	START	ENTRY	BASIC	PROFESSIONAL	ULTIMATE	MAXIMUM
DMX-Based Output						
DMX Channels	1,024	4,096	16,384	65,536	262,144	1,048,576
DMX Universe Example	2	8	32	128	512	2,048
RGB Voxels Example	341	1,365	5,461	21,845	87,381	349,525
DVI-Based Output						
DVI Voxels	4,096	16,384	262,144	1,048,576	2,097,152	2,097,152
Render Resolution Example	64 X 64 PIXELS	128 X 128 PIXELS	512 X 512 PIXELS	1,024 X 1,024 PIXELS	2,048 X 1,024 PIXELS	2,048 X 1,024 PIXELS

Controls



Touchscreen

ARTNET-S-8-512
8 port universe Artnet to DMX interface, 4096 DMX channels
Programable for playback and live support
(Online or Offline option)



Touchscreen

TVOQ-10-XX-7
XX = BK (black), WH (white)
1024 DMX channel, 500 scene,
10 zone, glass touch screen



Touchscreen

TVOQ-2-BK
Black
512 DMX channel, 99 scene,
1 zone, glass touch screen



MDRX-AURA-XX
X = 08, 16, 32 (ports)
MADRIX Luna 4, 8, 16 port
universe Artnet to DMX
interface. Programable for
playback and live support
(Online or Offline option)

Network Hardware



MDRX-LUNA-XX
X = 04, 08, 16 (ports)
MADRIX Luna 4, 8, 16 port
universe Artnet to DMX interface
16 port 8192, 8 port 4096, 4 port
2048 DMX channels



ARTNET-L-X-512
X = 8, 16 (ports)
8 or 16 port universe Artnet to
DMX interface,
16 port 8192 DMX channels
8 port 4096 DMX channels



NTG-SWI-16PT
NETGEAR 16-Port Gigabit
Ethernet
Unmanaged Switch



NTG-SWI-8PT
NETGEAR 8-Port Gigabit
Ethernet
Unmanaged Switch



DMX-SPLT-8
DMX Splitter
1 Input to 8 Output
Ethernet or Hardwire Connection

Power Supplies

DESCRIPTION	CAT NO	APPLICATION	PRIMARY VOLTAGE	SECONDARY VOLTAGE	CIRCUIT BREAKERS	MAX LOAD	CIRCUIT CAPACITY	DIMENSION
ADUL Series Class 2 Transformer	ADUL-120-1-4-24-D	INDOOR/ DAMP	100-277V AC 50/60 Hz	24V DC	1	96W	4A	10.00"W X 10.00" L X 4.00" D
	ADUL-240-2-4-24-D				2	2x96W	2x4A	
	ADUL-320-3-4-24-D				3	3x96W	3x4A	